



Whole house heat recovery unit with a high-efficiency heat exchanger up to 92% setting and very low consumption EC motor.

Provides a constant supply of fresh tempered air into the living spaces of a house.

Domeo can communicate with home automation system via Modbus or other gateway protocols.

To optimise energy consumption and air quality, it can be connected to a CO₂ or humidity sensor and others.

Domeo 210 is fitted with a 100% bypass and it is equipped with F7 or M5 filters at the inlet and with G4 filters at the outlet to protect the heat exchanger.

Includes remote control, allowing adjustment of boost (in RD), by-pass and reset of clogged filters.

Versions:

- DOME0 210 FL 3V EU: Wired remote control. 3 speeds.
- DOME0 210 RD: Wireless remote control (by radiofrequency). Constant airflow motor.

Features

- Counter-flow heat exchanger with up to 92% thermal efficiency
- Low-consumption EC motor
- Centrifugal backward curved impeller
- Modbus communication
- EPP body
- Nozzles Ø125 mm
- 100% automatic or manual bypass
- Manual boost mode (RD models)
- Inlet filter:
 - F7 (ISO ePM1 65%, at 210 m³/h).
 - Option, M5 (ISO ePM10 50%, at 210 m³/h).
- Extraction filter G4 (ISO coarse 65%, at 210 m³/h).



Controller

Remote control included in the product allows regulation of:

- Boost function (RD models)
- By-pass
- Polluted filters alarm
- Unoccupied mode (RD models)



Very compact

Minimum width and depth.

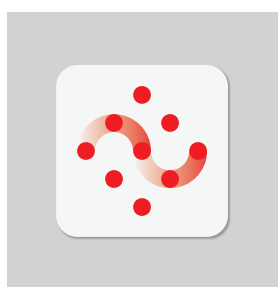

Connectair

Through the optional SPCM module, the unit can access Connectair, S&P's IoT that provides access to a new way to enjoy your ventilation.



DOME0 210 FL 3V

Specific applications



EASY MAINTENANCE



Easy access to filters.

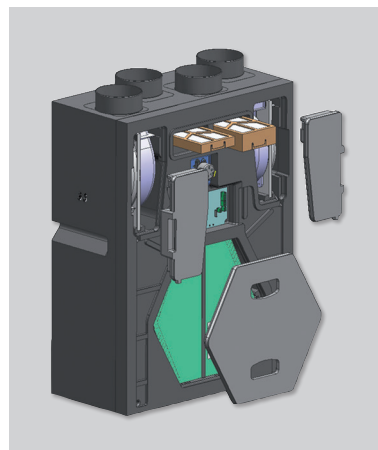
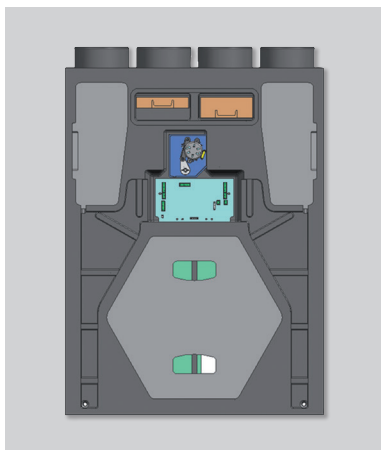

Easy to access: fans, heat exchanger and by-pass.

TECHNICAL CHARACTERISTICS

Model	Efficiency (%)	Voltage (V)	Maximum airflow a 100 Pa (m³/h)	Sound pressure level at 1,5 m (120 m³/h - 70 Pa) (dB(A))	Absorbed power (W)
DOMEO 210 FL 3V EU	92	230	210	38,8	100
DOMEO 210 RD	92	230	210	38,8	100

PERFORMANCE CURVES

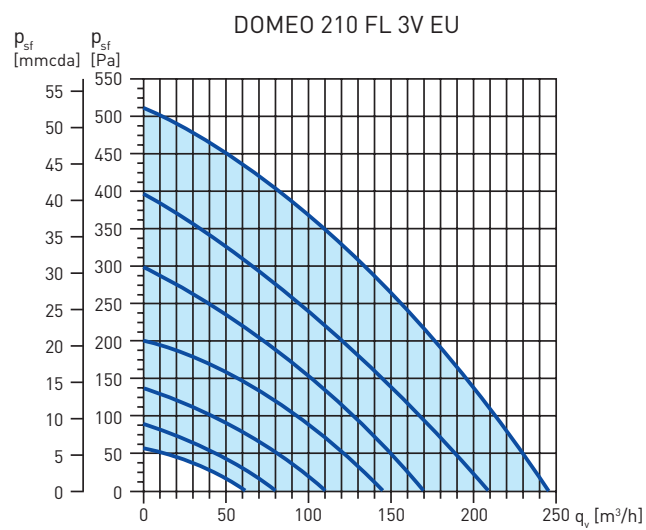

Area of adjustable speed

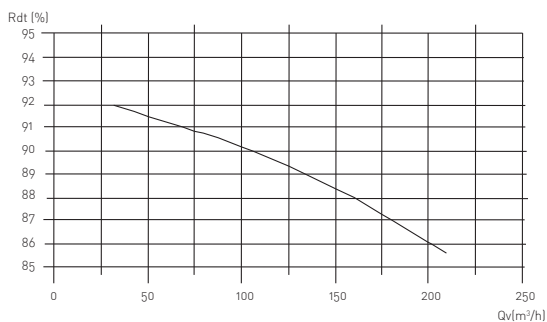

DOMEO 210 SERIES - CENTRALISED COUNTER-FLOW SYSTEM

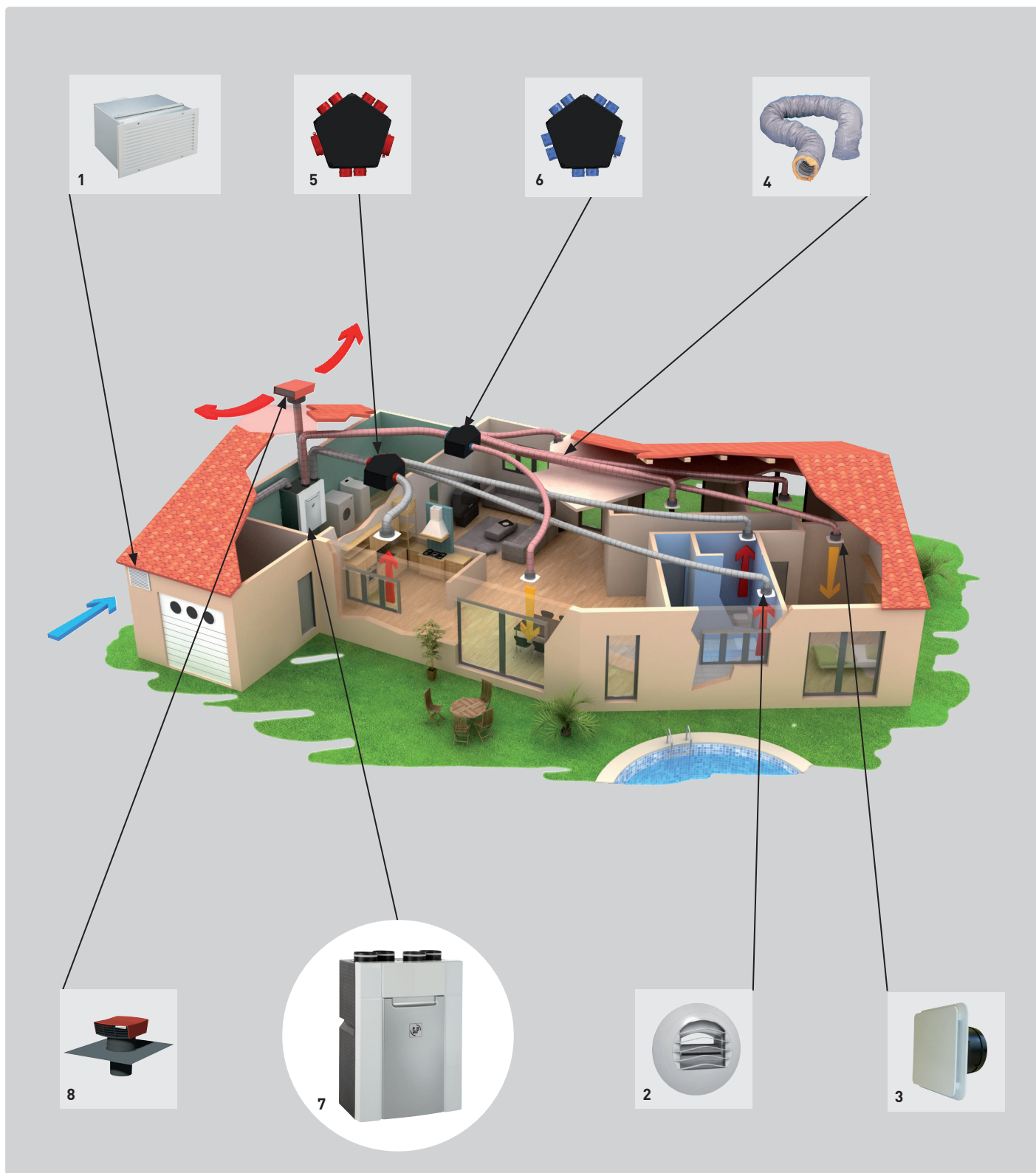

1. Air inlet grille TAP.
2. Self-adjusting extraction valve BARJ / BARP.
3. Supply and extraction valve BDOP.
4. PVC or rectangular plastic ducts.
5. Extraction plenum.
6. Supply plenum.
7. DOMEO 210: Counter-flow, high-efficiency heat recovery unit.
8. CT Roof termination.

EXAMPLE OF HEAT RECOVERY IN WINTER

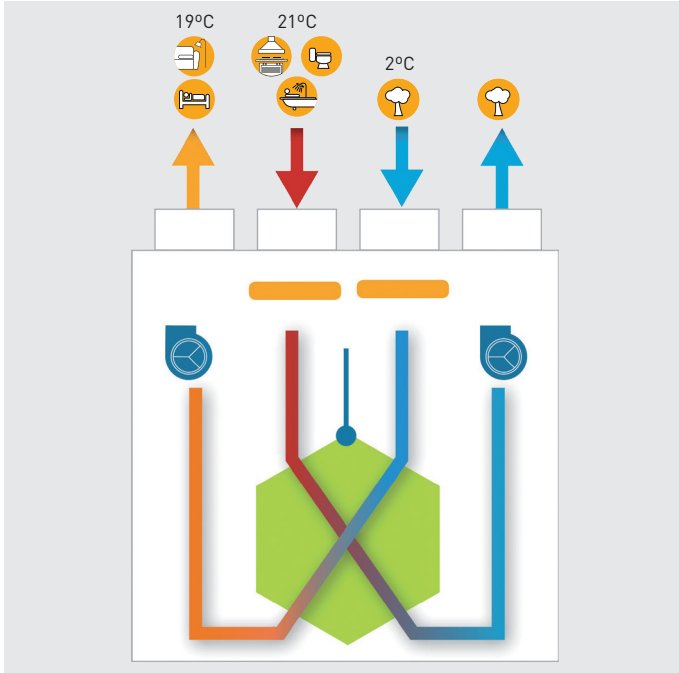

Operation without bypass

- Air inside home: 21°C.
- Outdoor air: 2°C.
- New air blown into home: 19°C.

With a mechanical extract ventilation system, the new air would enter at 2°C through the air inlets, decreasing the temperature inside home. With the energy recovery ventilation systems, the new air would enter at 19°C.

EXAMPLE OF HEAT RECOVERY IN SUMMER DURING DAYTIME

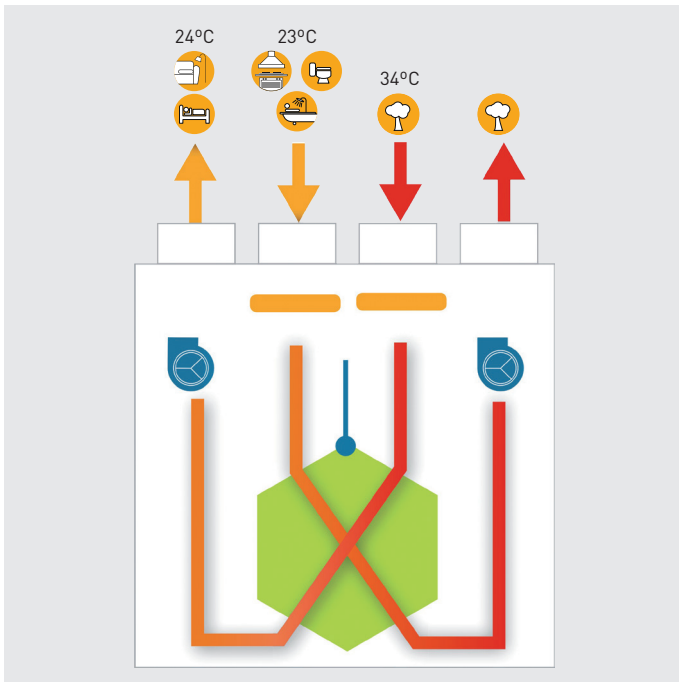

Operation with bypass

- Air inside home: 23°C.
- Outdoor air: 34°C.
- New air blown into home: 24°C.

With a mechanical extract ventilation system, the new air would enter at 34°C through the air inlets, increasing the temperature inside home. With the energy recovery ventilation systems, the new air would enter at 24°C and it will avoid the rising of interior temperature.

EXAMPLE OF HEAT RECOVERY IN SUMMER NIGHTS (FREE COOLING)

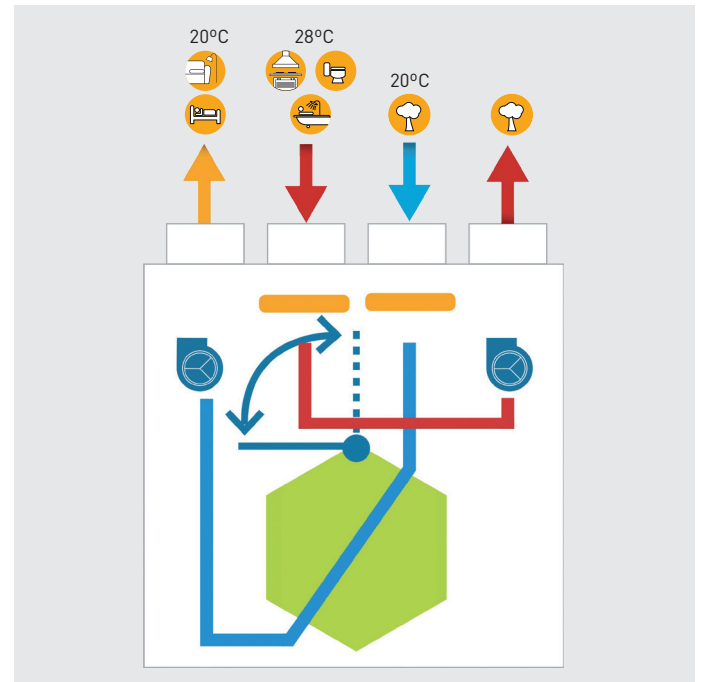

Operation with bypass

- Air inside home: 28°C.
- Outdoor air: 20°C.
- New air blown into home: 20°C.

In addition, during summer nights, when outdoor air is colder than indoor air, the bypass is activated automatically so airflows do not cross each other.

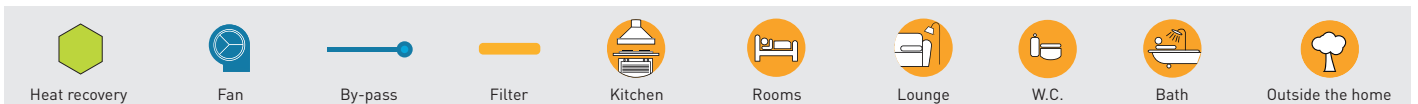

DIMENSIONS (mm)

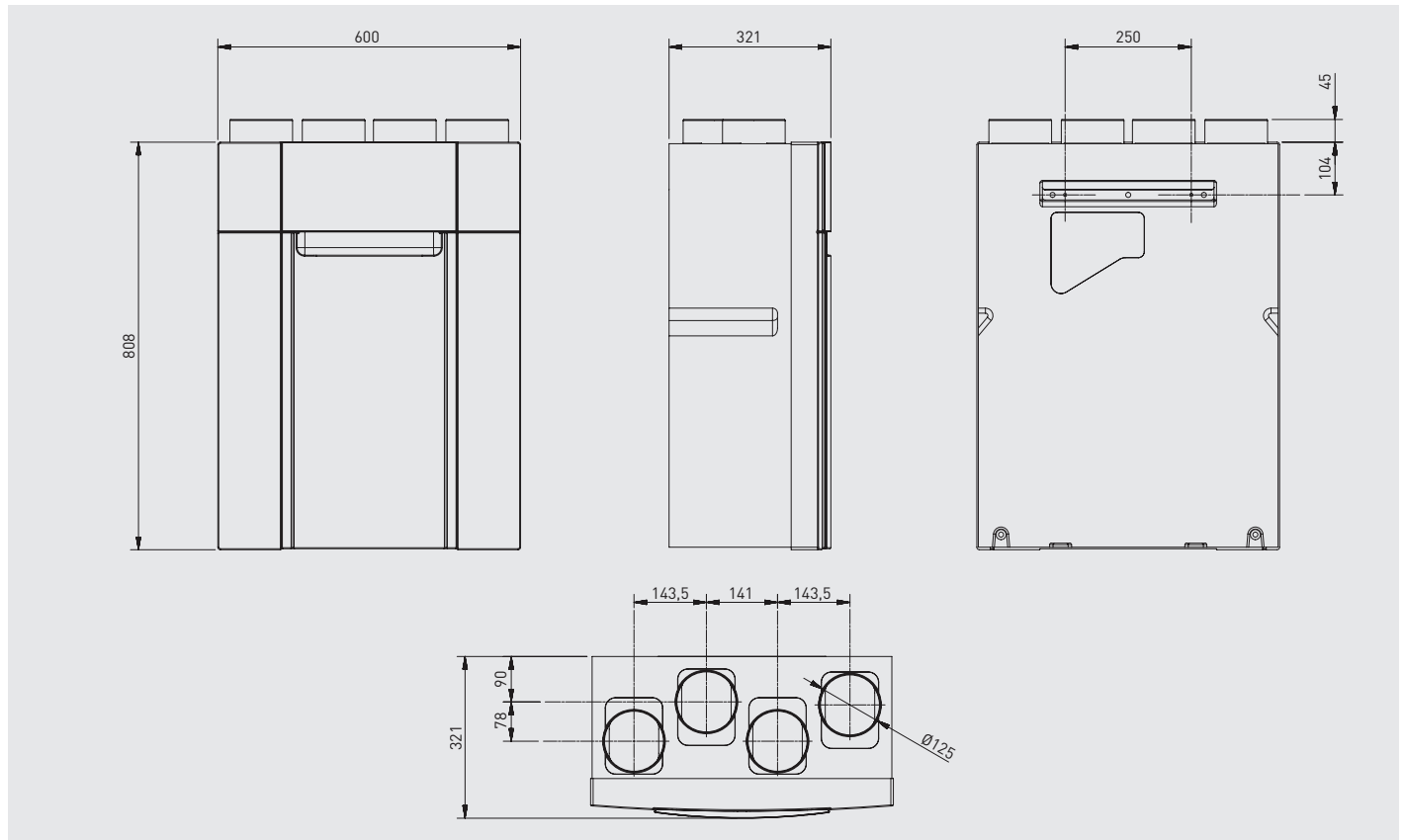

MOUNTING ACCESSORIES



KIT M5/G4 DOMEO
 Pack of M5 and G4 spare filters.

KIT F7/G4 DOMEO
 Pack of F7 and G4 spare filters.



Side trims

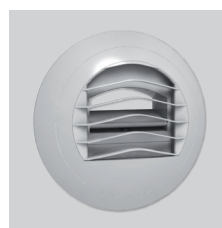

**BARJ
 BARP**
 Self-adjusting calibrated extraction valves.



BDOP
 Supply and extraction valve.



RDR
 Self-adjusting damper (50-250 Pa) that, fitted inside the duct, maintains constant airflow.

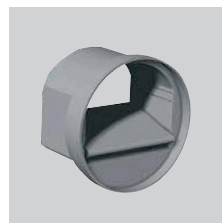

RD BP
 Specific low-pressure (20-100 Pa) and self-adjusting damper with sleeve to fit directly into the duct. 80mm diameter. Airflow: 15 or 30 m³/h.

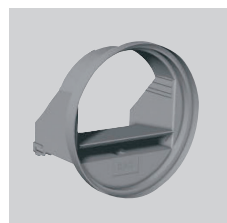

RD BP SM
 Specific low-pressure (20-100 Pa) and self-adjusting damper without sleeve to fit directly into the sleeve of the BDOP. 80mm diameter. Airflow: 15 or 30 m³/h.

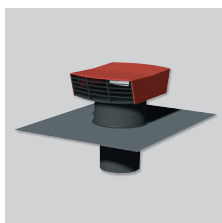

CT
 Roof cowl.

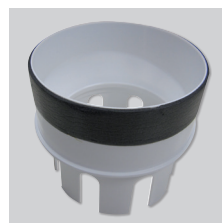

ADRF 100/80
 Reduction to connect rigid duct to spigots for flexible ducts.



GPR-ISO
 Insulated rigid duct.



**GP
 GPX
 GP-PRO
 GP-ISO**
 insulated PVC ducts .

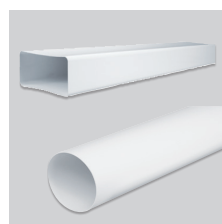

TUBREC
 Rectangular ducts in flame-retardant plastic.

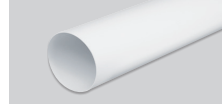

TUBCIR
 Circular ducts in flame-retardant plastic.



TAT
 Air inlet grille under roof.



TAP
 Wall mounted air inlet grille.



PAF
 Wall outlet grille.

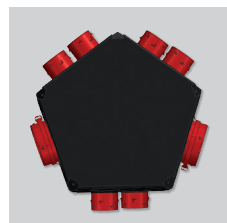

PLENUM UNI EXT 6+1
 Insulated extraction plenum of 125/ 150-160mm diameter, 1 Kitchen spigot of 125mm diameter and up to 6 sanitary spigots of 80mm diameter.

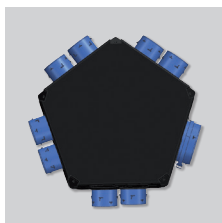

PLENUM UNI IMP 8
 Insulated supply plenum of 125/150-160 mm diameter and up to 8 spigots for dry areas (living room, dining room, bedrooms) of 80mm diameter.



LA
 Acoustic connections.



**FLEXIREC
 FLEXICIR**
 Oblong and circular semi-flexible ducts.

ELECTRICAL ACCESSORIES



AIRSENS-CO2
AIRSENS-VOC
AIRSENS-HR
Intelligent IAQ device
available in three
different versions:
CO2 or VOC or RH.



TSP-B
Remote control
functions:
• Standby
• **Time scheduler**
• Speed selection
• Manual bypass
• Filter alarm
• Remote control via
cable



SPCM WB
Communications
module.



AIRSENS RF
Single-phase
speed controller.